



Thinking ahead. Focused on life.

TORQTECH & Rotary Master+



TORQTECH

Experience a revolution in handpiece design.

TORQTECH is built tough and durable, yet provides a steady cut for even the most delicate of margins. TORQTECH's superb handling and comfort grip will make this the attachment you reach for time and time again.

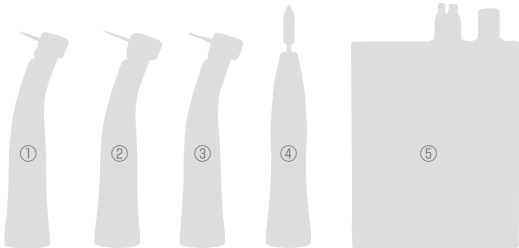



- ① CA-5IF-O-UM Ultra mini Contra Angle with 1:5 speed increasing gear ratio with optics
- ② CA-5IF-O / CA-5IF Contra Angle with 1:5 speed increasing gear ratio with or without optics
- ③ CA-DC-O / CA-DC Contra Angle with 1:1 gear ratio with or without optics
- ④ ST-DH Straight Attachment without optics
- ⑤ Rotary Master+

1:5 Contra-angles

Robust and durable with easy access



Easy access

The compact head improves visibility, while the comfort grip makes it easy to position. The angle is designed to help avoid contact with opposing teeth, allowing you to focus on treatment, rather than access.

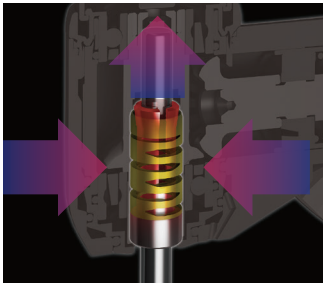

Unique, multi-point chuck
MORITA's unique chuck design grips the burr firmly and doesn't lose its strength even after years of use. Experience the stability only a TORQTECH can provide when performing work that requires great precision.

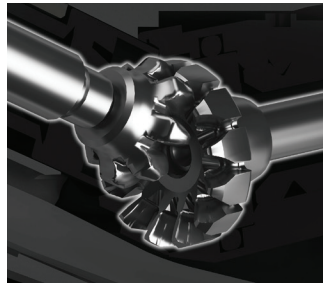

Highly durable involute gears
A unique combination of internal and involute gears provide superior durability by reducing wear and resistance.



1:5 Contra-angle Ultra mini

For maximum access and visibility

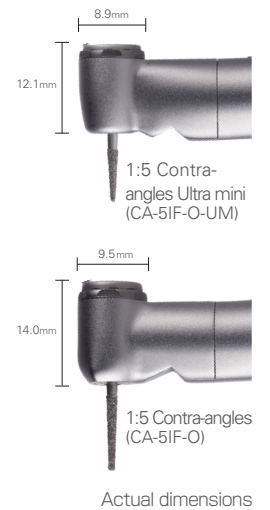

Improved access

The best just got better. The TORQTECH Ultra mini Contra-angle is ideal for treating patients with limited jaw mobility or children with small oral cavities. Use any standard friction bur up to 21mm and enjoy the stability and durability you've come to trust, now in a smaller profile.



See what you've been missing

The ultra mini head allows you to reach narrow treatment areas with ease and provides excellent visibility for fine, precise work.



Wide, one-point spray

Newly designed spray mechanism provides a wide spray ensuring adequate cooling in even the most challenging treatment areas.



TORQTECH Ultra Mini

1:5 High-Speed Contra Angle

- Compact head and bur design allow easy access, ideal for children and patients with limited jaw mobility
- High durability and efficiency ensure a long working life
- High-precision gear system minimizes rotation noise and reduces bur wobble
- Large cavity preparations are faster and easier to complete
- Smooth, corrosion-resistant surface stays clean longer and provides a comfortable feel
- Wear-resistant construction ensures long-term durability
- Long-lasting chuck delivers a secure, reliable bur grip
- Mini head and smooth body design improve access to hard-to-reach treatment areas



MORITA



- Perfectly balanced when used with the Rotary Master motor; lightweight components and forward-centered gravity enhance control
- Precision-engineered gears and chuck contribute to extended service life
- Low vibration and quiet operation reduce stress for both patients and clinicians
- A new high precision gear system reduces noise and bur wobble
- Preparation of large cavities is quicker and easier to accomplish



Regional Partner

Rotary Master + Electric Motor

Easy To Use, Powerful, and Safe

Rotary Master+ is an easy-to-use voice controlled electric motor that is easy to use, powerful, and safe. It is compatible with most competing electric handpieces on the market, and features a quiet and long-lasting brushless motor that is quick to power up and maintain a strong constant speed.





Regional Partner

Easy to Setup and Use

Rotary Master+ is easy to set up and use. It is compatible with almost all ISO standard electric e-type attachments. Attach any 4-hole handpiece hose and the motor is controlled by your existing treatment unit. And no technician is required to attach the 2-hole hose to the control box.

The motor also features a tablet that makes it the world's first voice controlled electric motor. The tablet clearly displays the current mode and settings, enabling the ability to make instant adjustments.

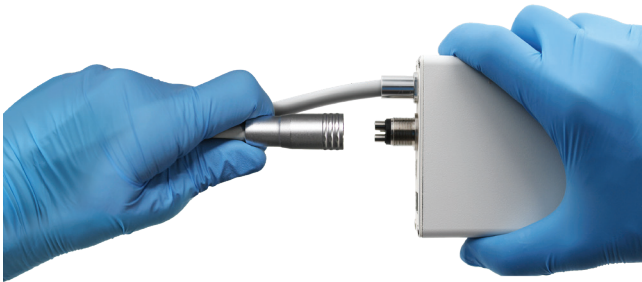

Powerful and Long Lasting

Rotary Master+ features a powerful and quiet brushless motor. The motor can maintain a constant speed up to 40,000 RPM, allowing for a powerful and consistent cutting speed for harder materials such as Zirconia and metal. A cartridge mounted bearing assembly eliminates chatter with less internal friction and heat. Rapid Response Technology delivers immediate power between the control box and motor. The result is a powerful and quiet motor that lasts longer, cuts harder, and provides better speed control.

Safe and Quiet

Three speed presets in various modes including 1:5, 1:1, and 4:1 reduce the risk of exceeding max bur speed, ensuring patient and dental team safety. The quiet sound quality and smooth cutting of the brushless motor reduces patient stress and anxiety. And a bright LED provides additional visibility for the clinician.

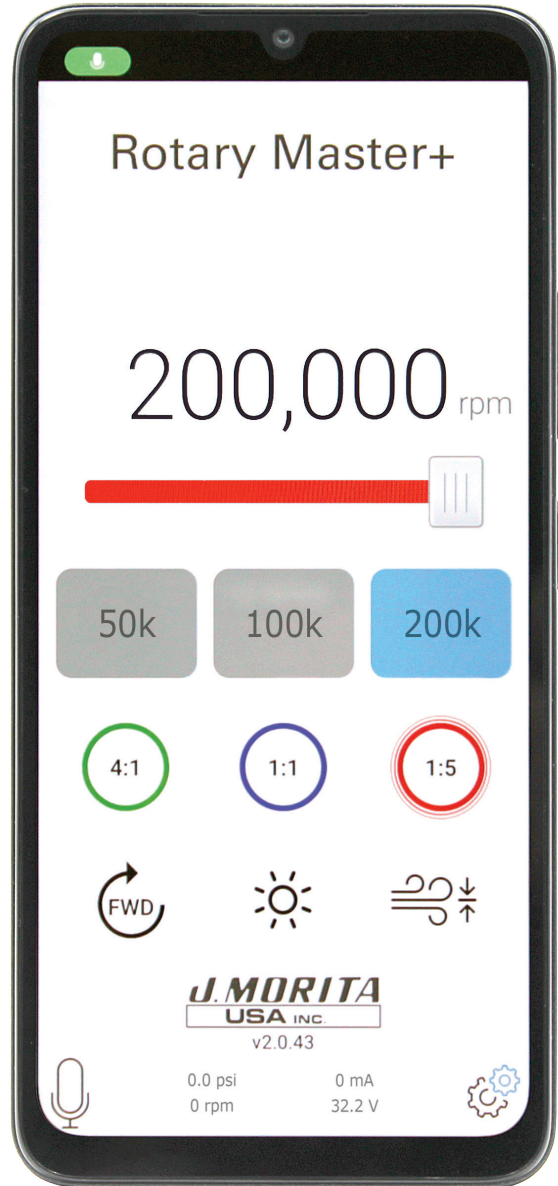

AirTorx Low Speed Air Motor

Powerful Torque Even at a Low Speed



Versatile and Powerful

Air Torx is versatile. It can be used for a wide range of tasks such as grinding of dentures, adjusting, finishing, and polishing restorations, and for tooth polishing with a prophyl angle.

Air Torx offers efficient, powerful, and constant torque with operational speeds up to 20,000 rpm. It generates about twice as much torque as conventional low speed air motors in the 5,000–10,000 rpm range, as illustrated in the chart below.

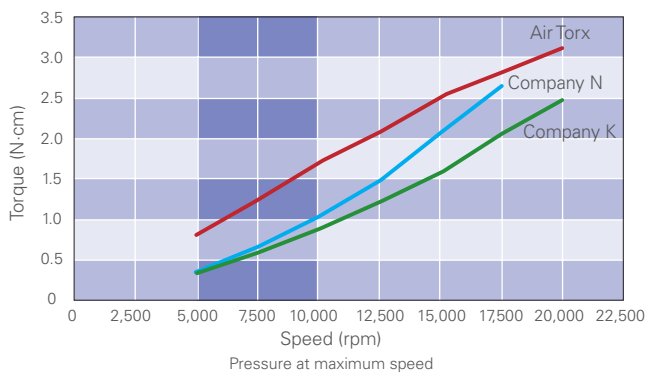

Fluid Dynamics

Air Torx offers quiet and smooth operation and generates highly efficient torque through innovative fluid dynamics.



Compatible with Standard ISO-Type Attachments

The Air Torx joint is compatible with TorqTech and any ISO 3964 straight attachment or geared angle attachment (without light only). The connection type to the tubing is standard 4-hole ISO 9168 Type 3* with an integrated water line.



Forward/Reverse Drive

Offers smooth power control and allows for continuous adjustment.

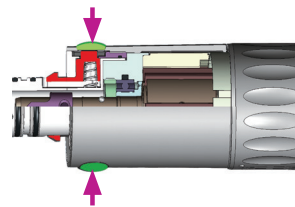

Double-Lock Connection

Double-lock connection mechanism is safer and easier to use than competitors' models.

Durable

Air Torx offers enhanced durability for a long working life. It is also autoclavable for complete infection control.

* Formerly Type C. ISO 9168 - Hose connectors for air driven dental handpieces was revised July 1, 2009. The type designation of handpiece joints was changed from letters to numbers.

Specifications

		
Name	Air Torx	Rotary Master+
Model	TRA-200	N/A
Rotation Speed	0 – 20,000 rpm	40,000 rpm
Length (motor section)	63 mm	71.7 mm
Diameter	21 mm	22 mm
Weight	Approx. 68 g (2.40 oz.)	Approx 70.1 g (2.47 oz)

J. MORITA
USA
Regional Partner

						
	Optic *1	Non-Optic	Optic *1	Non-Optic	Non-Optic	
Name	TORQTECH					
Model	CA-5IF-O	CA-5IF	CA-5IF-O-UM	CA-DC-O	CA-DC	ST-DH
Gear ratio	1:5 (speed-up)		1:5 (speed-up)	1:1		1:1
Maximum Rotation Speed (rpm)	40,000		40,000	40,000		40,000
Head Diameter (mm)	Φ 9.5		Φ 8.9	Φ 9.5		-
Head Height (mm)	14.0		12.1	13.3		-
Total Length (mm)	94		93	94		83
Weight (g)	68		66	67		73
Glass Rod Light Guide	○	-	○	○	-	-
Surface Treatment	Ion plating					
Spray Holes	3		1 (wide one-point spray)	1		1
Spray Filter	○	-	○	○	-	-
Bur Insertion/Removal Method	Push button				Mechanical locking	
Usable Burs *2	Shaft Type 3 (FG)		Shaft Type 3 (FG) Standard shortshank	Shaft Type 1 (CA)		Shaft Type 2 (HP)
Usable Motor	Motor conforming to JIS T5912 / ISO14457					

For models with optic and non-optic versions, a photo of the optic version represented.

※ 1 : Cannot be connected to non-optic motors with the exception of the Air Torx Motor.

※ 2 : Use burs that conform to ISO1791-1 or JIS T 5504-1.



Spray Filter

Optical models come equipped with an easy to clean spray filter that helps keep your cooling spray reliable.



MORITA MULTI SPRAY

Specially designed lubricant to optimize the performance of TORQTECH and maintain its durability.

Ordering Information

Handpieces	Motors and Accessories
16-5352975 TorqTech 1:5 Speed Up Contra Angle (CA-5IF-O) (with light)	16-5350611 Air Torx Low Speed Air Motor (TRA-200)
16-5352975 TorqTech 1:5 Speed Up Contra Angle (CA-5IF) (without light)	165350000 Rotary Master+ Electric Motor
16-1908231 TorqTech 1:5 Ultra mini Contra Angle (CA-5IF-O-UM) (with light)	24-5010201 Multi Spray (420 ml)
16-5352959 TorqTech 1:1 Contra Angle (CA-DC-O) (with light)	
16-5352967 TorqTech 1:1 Contra Angle (CA-DC) (without light)	
16-5352940 TorqTech 1:1 Straight (ST-DH)	



Development and Manufacturing
J. MORITA MFG. CORP
680 Higashihama Minami-cho, Fushimi-ku,
Kyoto 612-8533, Japan
T +81. (0)75. 611 2141, F +81. (0)75. 622 4595

Morita Global Website
www.morita.com

Distribution
J. MORITA CORP
3-33-18 Tarumi-cho, Suita-shi, Osaka 564-8650, Japan
T +81. (0)6. 6380 1521, F +81. (0)6. 6380 0585

J. MORITA USA, INC.
9 Mason, Irvine CA 92618, USA
T +1. 949. 581 9600, F +1. 949. 581 8811

J. MORITA EUROPE GMBH
Justus-von-Liebig-Strasse 27b, 63128 Dietzenbach, Germany
T +49. (0)6074. 836 0, F +49. (0)6074. 836 299

MORITA DENTAL ASIA PTE. LTD.
3 Science Park Drive,
#01-05 The Franklin Singapore Science Park1, Singapore 118223
T +65. 6779. 4795, F +65. 6777. 2279

J. MORITA CORP. AUSTRALIA & NEW ZEALAND
Suite 2.05, 247 Coward Street, Mascot NSW 2020, Australia
T +61. (0)2. 9667 3555, F +61. (0)2. 9667 3577

J. MORITA CORP. MIDDLE EAST
4 Tag Al Roasaa, Apartment 902, Saba Pacha 21311 Alexandria, Egypt
T +20. (0)3. 58 222 94, F +20. (0)3. 58 222 96

J. MORITA CORP. INDIA
Filix Office No.908, L.B.S. Marg, Opp. Asian Paints, Bhandup (West), Mumbai 400078, India
T +91-22-2595-3482

J. MORITA MFG. CORP. INDONESIA
28F, DBS Bank Tower, Jl. Prof. Dr. Satrio Kav. 3-5, Jakarta 12940, Indonesia
T +62-21-2988-8332, F + 62-21-2988-8201

SIAMDENT CO., LTD.
71/10 Mu 5, Thakham, Bangpakong, Chachuengsao 24130, Thailand
T +66. 38. 573042, F +66. 38. 573043
www.siamdent.com

Diagnostic and Imaging Equipment

Treatment Units

Handpieces and Instruments

Endodontic System

Laser Equipment

Laboratory Devices

Educational and Training Systems

Auxiliaries